



moto
gadget

Instruction Manual
mo.unit basic & mo.unit blue

only valid from serial no. 00074000
(refer to serial sticker on the device)
and from Firmware 1045

V2.4

CAUTION!

THIS PRODUCT OPERATES ON STRONG CURRENTS. CONNECTION FAILURE MAY LEAD TO CABLE FIRE OR EXPLOSION OF THE VEHICLE'S BATTERY. THERE IS A RISK OF SEVERE OR LETHAL INJURIES.

IF YOU ARE NOT A CERTIFIED MOTORCYCLE TECHNICIAN, PLEASE STOP HERE AND ASK YOUR LOCAL MOTORCYCLE SHOP FOR PROFESSIONAL INSTALLATION.

SEMICONDUCTOR SWITCHES IN USE! MEASURED VOLTAGES AT TERMINALS ARE NOT SUITABLE TO DIAGNOSE A FAILURE OR DEFECT.

MOUNTING ON UNEVEN FACES WILL CRACK THE HOUSING AND CAUSE A FAILURE.

Thank you very much for purchasing a high quality *motogadget* product - Made in Germany.

Please read the following information and recommendations **thoroughly** and follow these instructions during installation and use of the instrument. No liability shall be assumed by motogadget for damage or defects resulting from negligence or failure to follow the operating and installation guide.

Contact:

motogadget GmbH
Köpenicker Str. 145
10997 Berlin
Germany

Tel. +49 (0)30 6900410-0
www.motogadget.com
info@motogadget.de

Copyright © 2009-2020 by *motogadget* GmbH, Berlin
motogadget and *mo.unit* are registered trademarks of
motogadget GmbH, Berlin, Germany.

1 Review of Delivery

All products from *motogadget* are thoroughly checked to ensure they are completely fault-free when dispatched. Please check the received goods immediately for possible transport damage. If you find any damage or other deficiencies, please contact us immediately.

In this regard, we refer to our General Terms of Business and Delivery, which are published at www.motogadget.com. Should a return of the received delivery be agreed, please note that we only take back goods in their original packaging. The mo.unit and its accessories must be returned within the legal period of time and without any traces of use. We shall not assume any liability for returns which are insufficiently insured or packed.

2 Exclusion of Liability

THE *MO.UNIT* OPERATES STRONG CURRENTS. FAULTY CONNECTION MAY LEAD TO CABLE FIRE OR EXPLOSION OF THE VEHICLE'S BATTERY. THERE IS A RISK OF SERIOUS OR LETHAL INJURIES. A MAIN VEHICLE FUSE (MAXIMUM 40A) MUST BE USED. THE DEVICE AND ITS ACCESSORIES MUST BE INSTALLED BY A CERTIFIED MOTOR-CYCLE TECHNICAN AND IN AN AUTHORIZED SERVICE CENTER. REVERSE POLARITY OR VOLTAGE ABOVE 25V MAY RESULT IN DAMAGE TO THE *MO.UNIT*. THE DEVICE THEN HAS TO BE REPLACED AND ALL CLAIMS OF WARRANTY ARE DELETED.

***MOTOGADGET* ACCEPTS NO LIABILITY FOR DIRECT OR INDIRECT DAMAGE OR SUBSEQUENT DAMAGE OF ANY KIND RESULTING FROM THE USE, INSTALLATION OR CONNECTION OF THE DEVICE OR OTHER DELIVERED EQUIPMENT. THIS EXCLUSION OF LIABILITY PARTICULARLY INCLUDES DAMAGE TO PERSONS, MATERIAL LOSSES AND FINANCIAL DAMAGES.**

THE USE IN AREAS OF PUBLIC TRAFFIC ENSUES AT THE USER'S OWN RISK. DEVICE HOUSINGS AND ALL OTHER DELIVERED PARTS MUST NOT BE OPENED OR DISMANTLED. IN CASE OF NON-COMPLIANCE, ALL WARRANTY CLAIMS BECOMES INVALID. THE USE OF THE DELIVERED DEVICE AND ITS ACCESSORIES FOR RACING OR OTHER COMPETITIONS AS WELL AS FOR ANY USE NOT CORRESPONDING TO THE RECOMMENDED APPLICATION ALL WARRANTY CLAIMS SHALL BE INVALID.

3 Safety Instructions

- THE VEHICLE BATTERY MUST BE COMPLETELY DISCONNECTED PRIOR TO ANY WORK ON THE VEHICLE'S ELECTRICAL SYSTEM. FIRST, DISCONNECT THE NEGATIVE TERMINAL AND THEN THE POSITIVE TERMINAL. FOR RECONNECTION PROCEED IN THE REVERSE ORDER.
- USING THE *MO.UNIT* WITH PLUS POLE CONNECTED TO VEHICLE FRAME (OLDER ENGLISH MOTORCYCLES) IS NOT POSSIBLE.
- INSTALLATION AND ELECTRICAL CONNECTION OF THE *MO.UNIT* MAY ONLY BE CARRIED OUT BY A CERTIFIED MOTORCYCLE TECHNICIAN.
- ALL CABLE DIAMETERS MUST BE DIMENSIONED ACCORDING TO THE CURRENT FLOW (REFER TO CHAPTER 8.5).

- **ALL ELECTRICAL CONNECTIONS IN THE WIRING LOOM AND AT THE CONNECTION TERMINALS HAVE TO BE CARRIED OUT PROFESSIONALLY. FAILURES AT CONNECTING JOINTS MAY CAUSE A CONTACT RESISTANCE AND LEAD TO HEAT GENERATION DURING HIGH CURRENT FLOW. THERE IS A RISK OF SERIOUS OR LETHAL INJURIES.**
- **THE DEVICE WILL BECOME DAMAGED BEYOND REPAIR IF A BATTERY CABLE IS DISCONNECTED (DUE TO LOOSE OR WORN CONTACT ETC.) WHILE THE ENGINE IS RUNNING. PLEASE MAKE SURE THAT THE VEHICLE'S BATTERY IS CONNECTED CORRECTLY AND THAT THE CONNECTOR CABLES ARE FIXED TIGHTLY.**

4 Duty of Registration

The *mo.unit blue* does not have to be registered. The user is responsible for ensuring that the chosen settings for the vehicle lighting conform to the laws in the country of use. This must be checked in each case by the user before starting the device.

5 Technical Data and Functions

5.1 General data

Length / width / depth	90 / 53 / 30mm
Weight	110g
Threaded fastening bores	2 x M5, bore spacing 74mm
Standby current	approx. 500 μ A without Bluetooth / 950 μ A with Bluetooth

Operating voltage	6 - 18V, suitable for 12V electrical systems only
Operating temperature	-20°... + 80°C
Input circuits	12
Output circuits	10 (<i>START</i> and <i>AUX2</i> with 2 wire terminals each)
Display	23 internal LEDs

5.2 Differentiating the *mo.unit basic* from an *mo.unit blue*

The *mo.unit basic* does not feature Bluetooth functionality and therefore can't be paired with a smartphone. The *mo.unit basic* is labeled with a **red** serial number sticker and the *mo.unit blue* will have a **silver** serial number sticker.

To upgrade an *mo.unit basic* to an *mo.unit blue*, the item needs to be shipped to *motogadget*. The upgrade will take approximately two weeks and costs 120 EUR + shipping.

5.3 Device cold-start and warm-start

At a cold-start the battery will be connected to the *mo.units* M5 terminal and ground. This is initialising the *mo.unit* which may take up to 20 seconds. In this time all LEDs will be pulsing some seconds for testing.

For a warm-start the input *LOCK* is connected to battery +12V. This will put the *mo.unit* in its operational mode and switches the vehicle electrical system. In normal operation vehicle electrical system is switched on and off by the *LOCK* input only.

IN ORDER TO SWITCH THE VEHICLES ELECTRICAL SYSTEM, DO NOT DISCONNECT THE BATTERY FROM THE *MO.UNIT*.

5.4 Overview

serial number
(required for support request)

indicator light for
in/output status

inputs (12)
max. wire cross section 1,5mm²

Bluetooth icon
(illuminated if
Bluetooth active)

mounting screw
(M5) pitch 74mm
ground connection

mounting screw
(M5) pitch 74mm
alternative
ground connection

battery plus terminal
(M5) via main fuse

plug in / release cable connector by pressing
orange button with screwdriver blade

outputs (10)
max. wire cross section 2,5mm²

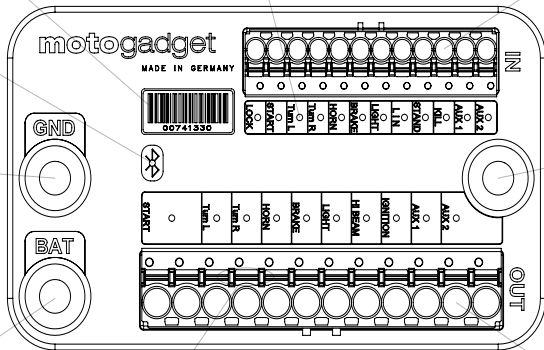

6 Functions and Operation

The *mo.unit* act as the central control unit in the vehicle's electrical system. It provides the following features:

- Complete digital pushbutton control unit; optional 4 or 5 pushbutton operation
- Complete replacement of all OEM fuses. 10 independent circuits are digitally supervised; a circuit will be shut down in case of interferences. On removing the interference the safety feature will be automatically reset
- Integrated, digital, load-independent flasher relay; with programmable switch-off feature (optional), selectable mo-wave mode
- Direction indicator setting for use as position light
- Integrated digital brake-light modulator with programmable flashing sequence, acceleration-controlled emergency brake light
- Pairing of *mo.unit* with other *motogadget* products via LIN bus
- Integrated starter relay for solenoid switch (up to 30A switching capacity)
- Smart and fully configurable load control / shut-off for maximum starting power of battery on starting process
- Low and high beam control (up to 120W switching power) using just one push-button
- Integrated digital horn relay
- Integrated position-independent alarm system
- Integrated hazard light feature
- Diagnostic feature for layout of input, output, circuit switching status plus diagnosis of electrical circuit, short-circuits, etc.
- Two fully configurable auxiliary outputs *AUX1* and *AUX2*
- Calibration and current monitoring allows defect detection of all lights and blinkers

Connecting with your smartphone and *mo.ride* app (not *mo.unit basic*)

- Secure encrypted Bluetooth-LE (Low Energy) connection
- Keyless-Go: unlock your bike's electrical system when approaching with your smartphone
- Reporting of alarm events (date, time, vehicle "down" etc.)
- Real-time blinker sound and vehicle fault indication via audio voice to headset
- Live display of input and output status, temperature, current and voltage measurements as well as total power consumption
- Override *mo.unit* outputs via the *mo.ride* App (except starter)
- Firmware updates anywhere, anytime
- Easy configuration of *mo.unit* setup menu
- The *mo.unit*'s speedometer input for storage and matching of vehicle's odometer is allowed for vehicle management with automatic notifications of maintenance tasks and status of wheels, chain, brake pads, oils, operating supplies, spark-plugs, etc.
- Tour, status, alarm, and maintenance logbook
- Features "last ride" and tourlog with fun-factor, curve count, topspeed, distance, weather, riding duration and tourmap daily summarized with all intermediate stops
- Riding saison overview with benchmark to the *mo.ride* community
- Display of parking position and "ping!" feature to locate your vehicle

The *mo.unit* is made of a newly designed high-performance thermosetting plastic and is resistant to moisture, heat, cold and vibrations. Microprocessor-operated and supervised circuits guarantee highest reliability. Current flow of each circuit is measured with high accuracy. In case of failure such as a short-circuit, the connection circuit affected is instantly shut down. All switching activities are performed by state-of-the-art semiconductor switches in a fast, wear-free and almost lossfree way.

No other devices, relays, boxes or units as part of the wiring harness are therefore necessary. A complete new and minimized vehicle wiring solution can be undertaken in little time with minimal materials and effort. Compared to conventional solutions, only a fraction of the space and cables are needed. State-of-the-art technology such as pulse-width modulation requires only one cable for connecting the rear and brake light. When using the mo.button, the number of handlebar instrument connections are reduced to a single cable by use of our interference-free proprietary data bus.

The current status of each circuit is shown by an internal LED at the *mo.unit's* topside:

- LED off - input not active, output not powered
- LED on - input active, output powered – normal condition
- Short flashing - output shut-down due to short-circuit or overload

Direction indicators

Automatic distance or time dependent shut-off can be activated in the setup menu. If this feature is activated, a countdown will start once the signal is flashing. When the set countdown has ended, the direction indicators stop flashing. Activating the brake stops the countdown. Releasing the brake restarts the countdown in its full time length. If pushbuttons are used for the direction indicator control and a timeout has been selected in the setup, a brief pressing of the pushbutton activates the lane change function (3 times flashing). Pressing and holding down the pushbutton for longer than one second deactivates the shut-off.

For the distance dependent shut-off a speed sensor is required. This option at speeds below 10km/h will set the blinker off after 50m riding distance, while speeds higher than 10km/h will set the blinker off after 10s.

Hazard light

To activate the hazard light press and hold down the pushbuttons for left and right direction indicators for 2s. If a direction indicator switch is used, toggle the switch three times from one side to the other briefly. The hazard light mode will stay active even if the main switch (ignition) is deactivated.

Light control

In order to save the vehicle's battery power, the light is off when switching ignition lock on. Low beam will be activated automatically after cranking the engine by pressing the start button. Further light control modes can be selected under setup menu no. 8.

If a pushbutton is used for high / low beam control, a short press will toggle between high and low beam. Pressing the pushbutton down for 2s will switch the lights off completely. Pressing the push button again will switch the low beam back on. A very brief press of the pushbutton will activate high beam flashing.

When using a switch for light control, it is only possible to toggle between high and low beam. Please refer to connection diagram.

The light outputs (*HiBEAM* and *LIGHT*) can switch 120W each and are designed for a maximum load of two halogen bulbs with 55W (low beam) and 60W (high beam) respectively.

The parking light (setup menu no. 12) is switched on when the high beam will be activating while the ignition is turned off. Depending on setup either the parking light is generated by dimming the main low-beam or by an additional parking light illuminant connected together with the rear light at output *AUX1*. Because LED headlamps can not be dimmed the use of a parking light illuminant is required in this case.

Engine kill

The running engine can be shut off in three different ways:

a) Double-clicking on the engine start button.

Pressing the button again will start the engine again.

b) Connecting a separate kill switch or a pushbutton at the *KILL* input. In the case a pushbutton is used, the engine will shut off if the pushbutton is briefly pressed. To restart the engine, hold the button again for 2s or switch the ignition on again. In the case a kill switch is used, wait for 2s after switching the engine off before releasing the kill switch. A kill switch or pushbutton and the *mo.button* can not operate at the same time at *mo.unit* input *KILL*.

c) When implementing controls with four push-buttons and choose the setup menu no.1 / option E, the engine is shut off by pressing the pushbuttons for the right indicator and the lights at the same time.

Alarm system

The sensitivity of the alarm system is independent of its positioning and orientation. On switching off the ignition, an activated alarm system is displayed by the indicators briefly flashing. The vehicle's relative position and orientation will be recorded and stored and the alarm system will be engaged after 30s. The alarm is triggered when the orientation of the vehicle is changed on its X, Y or Z axis (e. g. when the vehicle is raised from its kickstand). Depending on the pre-set sensitivity the alarm will also be triggered in case of lighter shocks or agitation response. Depending on the chosen setup the alarm system will trigger a pre-alarm and will only activate the alarm when the system is triggered again in a ten-second time frame.

If the vehicle is transported (e.g. by ferry, trailer or tow-truck) the alarm system can be deactivated non-recurring by pressing the horn button while switching disengaging the main switch.

If implemented within cars or sidecars, we recommend the highest sensitivity setting (option F).

Keyless-Go (not *mo.unit basic*)

The pairing of the *mo.unit blue* with the *mo.ride* app and the presence of an engine-start pushbutton is a prerequisite of this feature (not possible with setup menu no. 1 / option E - 4 pushbutton controls). Keyless-Go can be activated or deactivated with the *mo.ride* app. The Keyless-Go trigger radius can be taught within *mo.ride*.

With this feature active, the vehicle will be unlocked if your smartphone enters the Keyless-Go trigger radius, which is indicated by fading-in the turn signals.

Now pressing the start pushbutton will switch on the ignition; pressing it again will start the engine. Double-clicking the button will shut off the running engine; another double-click will shut off the ignition.

When walking outside the Keyless-Go trigger radius, the vehicle will be locked and the alarm system activated (provided that it is activated in the setup menu). This is indicated by fading-out the turn signals.

ONCE IGNITION SYSTEM IS ACTIVATED IT WILL STAY ACTIVATED EVEN WITHOUT BLUETOOTH CONNECTION. MAKE SURE TO ALWAYS CARRY THE IGNITION KEY WITH YOU, SO YOU CAN START THE VEHICLE EVEN WITHOUT YOUR SMARTPHONE.

Speedometer sensor

A speedometer sensor is required for matching the vehicle odometer with *mo.ride*. If the vehicle is equipped with a speedometer sensor, connect the sensor signal cable to the *AUX2* input and select option A or B in setup menu no. 10.

If the speedometer sensor is equipped with two connection cables, connect the ground cable to the vehicle ground connection and the second cable to the *AUX2* input.

If no OEM speedometer sensor is equipped, use the sensor provided. For signal detection, mount one of the provided magnets with glue to one of the wheels. In this case, the distance from magnet to wheel axle is irrelevant. Mount the speedometer sensor with a retaining plate in such a way that the surfaces of magnet and sensor tip are parallelly aligned with a 1mm gap. The reed sensor tip should not be flush with the bracket; make sure it protrudes from the bracket by approx. 5mm. The bracket must be made from a non-magnetizable material like aluminum, stainless steel or plastics. When driving under load, the distance between magnet and sensor may not vary! When rotating the wheel, no magnetizable material (e.g. a steel-made bolt) may brush over the sensor tip.

The maximum tightening torque for the sensor mounting nuts is 1Nm. Please use thread lock (medium strength) for mounting.

For testing the connected speed sensor, rotate the concerning wheel and observe the *AUX2* input LED. With each sensed impulse the LED must flashing.

TO CALIBRATE THE SPEED SENSOR OF THE *MO.UNIT*, RIDE 50KM/H PRECISELY AND THEN PRESS THE HORN RAPIDLY 3 TIMES. THE CALIBRATION PROCESS WILL TAKE 5S AND IS INDICATED BY THE FLASHING OF THE BLINKERS. KEEPING A CONSTANT SPEED IS REQUIRED THROUGHOUT THE ENTIRE CALIBRATION PROCESS.

7 Mechanical Installation

Mount the device on a **flat** surface (metal base plate) free of tension using two M5 screws. No tensile or compressive force must be acting on the device housing. All warranties and extended warranties shall be deemed forfeit in the event of mechanical damage to the device.

The area of installation must be protected from spray water and a distance of 20cm away from hot engine or exhaust parts. Maximum ambient temperature must not exceed +80°C or go below -20°C.

THE *MO.UNIT* IS CONNECTED TO THE VEHICLE EARTH BY THE TWO MOUNTING SCREWS. THEREFORE, ONE OF THE MOUNTING SCREWS MUST BE CONNECTED DIRECTLY TO THE MINUS TERMINAL OF THE BATTERY.

8 Electrical Connection

8.1 General aspects

The device works in a voltage range between 6 to 16V DC (direct current) and is made for 12V electrical systems which use **battery minus terminal to vehicle frame**. Usage in vehicles without a battery is not possible.

MAKE SURE THAT THE VEHICLE IS EQUIPPED WITH INTERFERENCE-SUPPRESSED SPARK PLUGS OR IGNITION CABLES. THE MINIMUM DISTANCE BETWEEN IGNITION COIL OR HIGH TENSION CABLES AND *MO.UNIT* MUST NOT BE LESS THAN 10CM.

8.2 Safety functions

The overvoltage notification will trigger the horn when the voltage surpasses 16V - 40V (e.g. in case of a defective regulator). This prevents unnoticed battery cook-off and damage to appliances due to continued riding.

Loose battery cables result in voltage spikes up to 80V. In this case, the *mo.unit* activates all appliances to protect itself. However, the resulting protection is only short-term – prolonged (several seconds) or repeated voltage surges will burn out the connected appliances (e. g. low or high beam bulbs). When the voltage surge can no longer be compensated, burn out occurs and the respective output will become damaged permanently. Such damage is indicated by the defective low or high beam outlet. In this case, all warranty claims become forfeit.

REVERSING THE POLARITY OF THE BATTERY WILL CAUSE THE ACTIVATION OF ALL CONNECTED APPLIANCES TO PROTECT THE *MO.UNIT*.

PLEASE ENSURE TIGHT BATTERY CABLE CONNECTIONS. WHILE THE ENGINE IS RUNNING LOOSE CONTACTS CAN CREATE VOLTAGE SPIKES ABLE TO DAMAGE APPLIANCES AND *MO.UNIT* BEYOND REPAIR.

8.3 Fuses

While the *mo.unit* itself does not need a fuse, the implementation of a main vehicle fuse (maximum 40A) is mandatory, since the voltage regulator (connected to the battery via the main fuse) may malfunction and create a short circuit.

If cables are connected with a lesser diameter than indicated in chapter 8.5 (e.g. *motogadget* instruments or the *mo.lock*), they have to be protected by the cable fuses supplied.

8.4 Note on cable routing and connecting

Cables used in vehicles must be suitable for this application. We recommend our cable kit (order #4002031).

Cable insulation must be of an adequate thickness and the insulation material must have a resistance against fuel, oil, cold and heat. Please use only cables which are certified for use in vehicles.

Non-fused positive leads, which lead from battery positive terminal to the starter motor or the *mo.unit*, must have the shortest length possible. It is very important to protect the insulation of these cables against damage by wear. Additional insulation protection is necessary at the contact points between cables and vehicle parts.

Before routing cables, look for suitable cable paths. The cables should be as far away as possible from hot parts of the engine. Look for a suitable place for the respective cables to connect with their plugs and for the plugs to be connected with each other. You will usually find this in the head lamp housing, below the gas tank or in the cockpit. Make sure you take note of the required lengths of cables before cutting them for best fit. In this regard, it is important to consider the full lock of the handlebars as well as the front and rear wheel travel.

All cables should be routed free of kinks and should not be subject to any tension. For fastening the cables we recommend cable ties made of plastic material.

The cables are connected to *mo.unit* using spring terminal blocks. Press down the orange coloured insert, next to the cable entry to insert the exposed cable end into the terminal block. Use a screwdriver tip to push down the insert.

8.5 Wire cross-sections

Wire diameters used in a circuit are dependent on the current flow in that particular circuit. The plan below shows the minimum wire cross-sections used in the single circuits of the *mo.unit*. The installed wire cross-sections must not be less than the shown values.

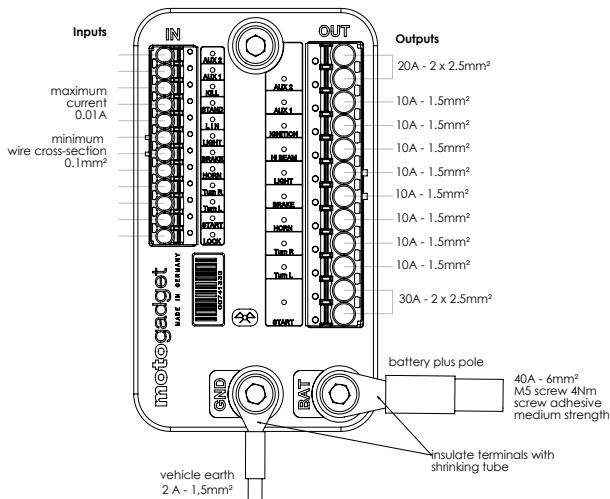

8.6 Connecting positive terminal of battery

Cable connection has to be carried out as shown in the drawing. The minimum wire cross-section must not be less than 6mm². The battery cable end has to be crimped on an M5 eyelet and be mounted to the *mo.unit* using a M5 screw. The maximum torque applied to the M5 fastening screw must not exceed 4Nm. Screw adhesive of medium strength **must** be applied to the screw prior to installation.

If the provided battery cable is used, mount the end with eyelet with the short M5 screw at the *mo.unit*. Cut the other cable end to required length and crimp the provided eyelet to this end. Use a suitable crimping tool. Use the provided shrinking tube to cover any exposed metal.

MAKE SURE THE EYELET IS SUFFICIENTLY INSULATED AND CANNOT MAKE CONTACT TO OTHER PARTS CONNECTED TO THE VEHICLE EARTH.

8.7 Handle bar controls

All input terminals, except terminal *LOCK*, require an earth signal. Five different types of handle bar controls are compatible with the *mo.unit*. The particular type to be used with the *mo.unit* must be set in the setup menu as follows:

Configuration A – 5 pushbutton controls

- Left indicator - pushbutton
- Right indicator - pushbutton
- Low/high beam - pushbutton
- Starter - pushbutton
- Horn - pushbutton

Configuration C – most Japanese and European motorcycles

- Left/Right indicator - 3-way switch
- Low/high beam - switch
- Starter - pushbutton
- Horn - pushbutton

Configuration E – 4-push-button controls (Keyless-Go is not possible)

- Left indicator - pushbutton
- Right indicator - pushbutton
- Low/high beam - pushbutton
- Horn - pushbutton
- Starter = press left indicator + light simultaneously
- Kill switch = press right indicator + light simultaneously

Configuration B – Harley Davidson and BMW controls

- Left indicator - pushbutton
- Right indicator - pushbutton
- Low/high beam - switch
- Starter - pushbutton
- Horn - pushbutton

Configuration D – new Ducati models

- Left/Right indicator - 3-way switch
- Low/high beam - pushbutton
- Starter - pushbutton
- Horn - pushbutton

When using the OEM handle bar controls together with the *mo.unit*, the high beam flashing pushbutton is not applicable. A side-stand switch has to be connected to input terminal *STAND*.

8.8 Connecting load circuits

The *mo.unit* provides 10 independent and permanently monitored circuits. The positive terminal is switched for all connected loads, i.e. a cable runs from each circuit to the corresponding load, which connects to earth. Only the intended load may be connected to the respective circuit. The connection scheme is shown on this page. Connect the control lamps as described in Chapter 8.9.

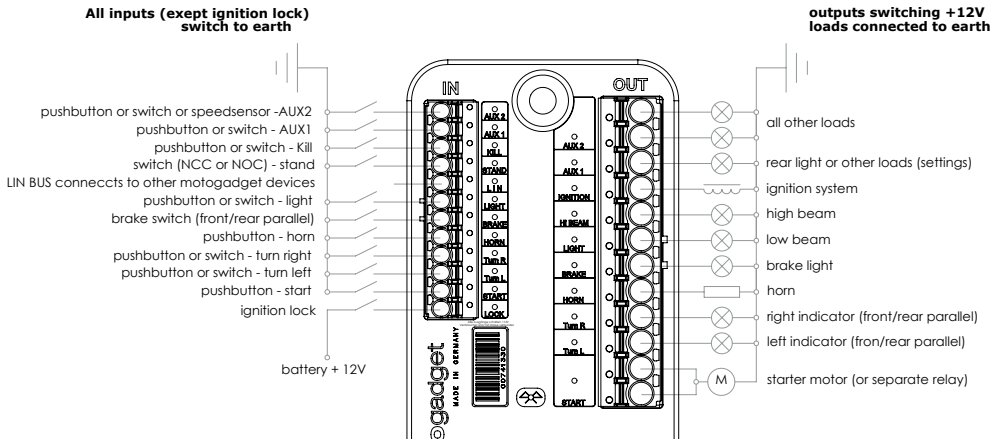

Overall schematic connection diagram

The circuit diagram below shows a simplified vehicle wiring loom

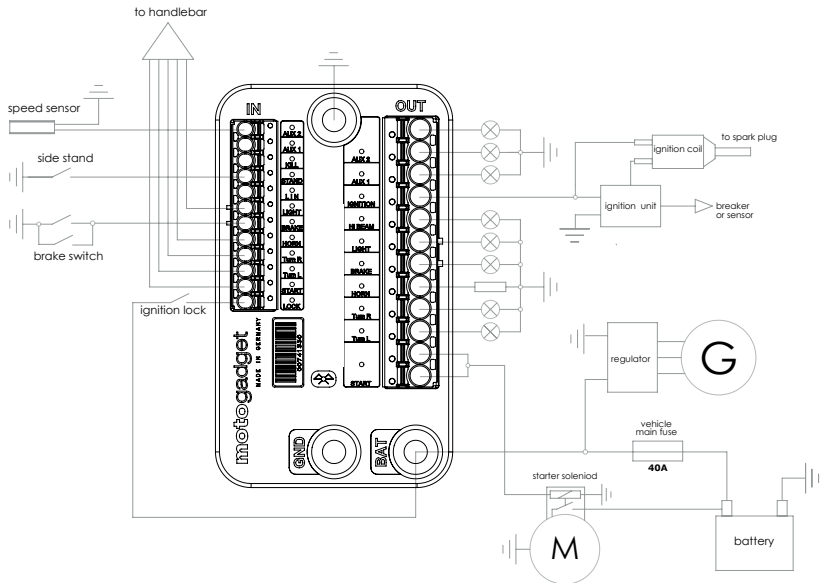

Overall schematic connection diagram with mo.button (optional accessory)

The circuit diagram below shows a simplified vehicle wiring loom when using the *mo.button*. In this case, 6 leads are dispensed with because only one cable is needed to connect the handle bar controls with the *mo.unit*.

**THE *MO.BUTTON* MUST BE LOCATED INSIDE A METAL HANDLEBAR TUBE.
EITHER THE *MO.BUTTON* OR A KILL SWITCH / BUTTON CAN BE CONNECTED TO THE INPUT *KILL* AT THE SAME TIME.**

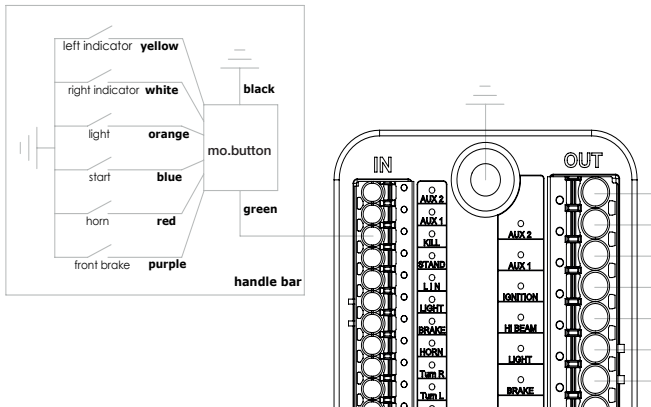

8.8.1 Special features

***START* output**

Starters with integrated solenoid (magnetic switch) with a current flow of maximum 30A (e.g. Valeo, Bosch, Harley Davidson) are connected by using two connection cables with 2.5mm² cross-section to the mo.unit's two START output terminals.

All starters with separate starter solenoid relays (e.g. Japanese models) must continue to be operated using the original starter solenoid relay. In this case, the START output is connected to the solenoid relay which switches the actual cranking current (>100A). On some vehicles, this starter solenoid relay is switched using a second relay for protection of the start pushbutton. This second relay can be dispensed with.

***IGNITION* output**

This output powers the ignition system.

THE IGNITION SYSTEM MUST BE CONNECTED TO THIS OUTPUT ONLY.

***AUX1* output**

All loads, such as the rear light, license plate light, radio, heated grips etc. are powered by this output. Different configurations of this output are possible in the setup menu – depending on the use.

***AUX 2* output**

This output is designed for multiple use and is equipped with 2 connecting terminals. Depending on the configuration, *AUX2* input can be used for switching operations (via pushbutton/switch) or alternatively, the switching can be automatically performed.

Ignition lock

When using the *motogadget mo.lock* as an ignition lock, the *mo.lock* switching output (brown cable) can be connected directly to the *mo.unit's* LOCK input.

For older Japanese models, resistors can be integrated into the ignition lock (simplified anti-theft protection). When bridging or removing the ignition lock the ignition system will not generate a spark, before a specific cable (directly routed from the ignition unit to the ignition lock) is switched to ground or high side (+) using an external resistor. The required resistor can be ordered in regular stores; the resistor value is determined by measurements.

If the vehicle is equipped with an immobilizer, in most cases this feature is deactivated via a built-in transponder inside the ignition key. In this case, it is not possible to bridge or remove the ignition lock.

According to the German Road Traffic Licensing Regulation (StVZO), the vehicle has to be equipped with a steering lock. If the ignition lock and steering lock are built as one unit, please clarify in advance whether you are permitted to carry the lock separately on you (e.g. as a brake disc lock) – this requires a registration in the vehicle documents.

One-wire rear light

With default wiring, the *BRAKE* output is connected to the brake light, and the rear light to the *AUX1* output.

If you want to connect the rear light and brake light with only one common wire, please select the correct setting in the setup menu no. 2 (refer to chapter 9). In this case, rear light and brake light will be switched together in parallel and connected to the *BRAKE* output.

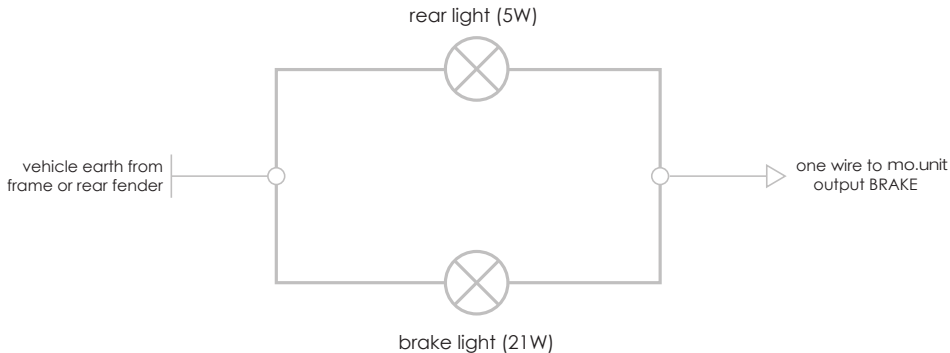

Emergency brake light

In this configuration (setup menu no. 4 / option G), a detected deceleration of more than 8m/s^2 over a time period in excess of 1s will be considered as an emergency braking event. The braking light will pulse with 5Hz and the hazard lights are active while braking. This is used to prevent collisions by giving clearly visible warning signals to the traffic behind you.

Use of original light-toggle switch with mo.unit

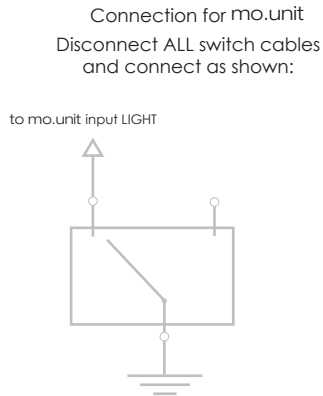
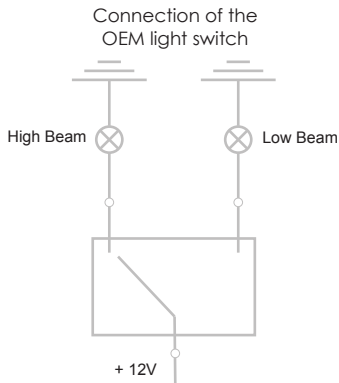

8.9 Connecting indicator lights

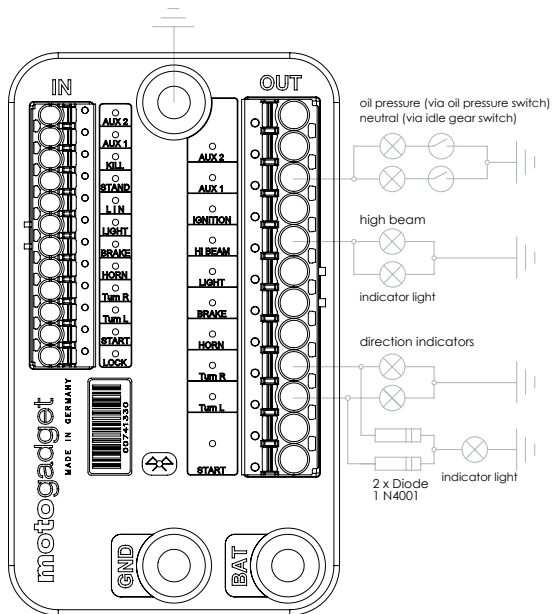

9 Setup

9.1 Layout

The device setup is structured in menus (1–12) with selectable options (A–J) as follows:

Menu 1 – Handlebar instruments

- A) Configuration A (use of 5 pushbuttons)
- B) Configuration B (Harley Davidson and BMW)
- C) Configuration C (Japanese and various European motorbikes)
- D) Configuration D (new Ducati models)
- E) Configuration E (use of 4 pushbuttons)

Menu 2 – Rear light configuration

- A) Standard (brake light connected to *BRAKE* and rear light to *AUX1*)
- B) One-wire rear light / brake light for LEDs
- C) One-wire rear light / brake light for light bulbs
- D) One-wire tail light bar (rear / brake) for LEDs

Menu 3 – Direction indicator configuration

- A) No automatic shut-down
- B) Distance depending shut-down at 50m or after 10s (speedsensor required)
- C) Time depending shut-down after 10s
- D) Time depending shut-down after 20s
- E) Time depending shut-down after 30s

Menu 4 – Brake light configuration

- A) Continuous light
- B) Fade in and fade out with 3Hz
- C) Flashing with 5Hz
- D) 8-time flashing with 5Hz and continuous light
- E) 2-time flashing then 1s continuous light – repeated
- F) 3s continuous light, then flashing with 5Hz
- G) Emergency braking – flashing with 5Hz and hazard lights

Menu 5 – Alarm configuration

- A) Alarm deactivated
- B) Silent alarm (alarm events displayed in *mo.ride* app only)
- C) Pre-alarm 10s, low sensitivity
- D) Pre-alarm 10s, medium sensitivity
- E) Pre-alarm 10s, high sensitivity
- F) Pre-alarm 10s, maximum sensitivity
- G) Low sensitivity
- H) Medium sensitivity
- I) High sensitivity
- J) Maximum sensitivity

Menu 6 – Direction indicators as position lights (low light)

- A) Function deactivated
- B) Brightness 10%
- C) Brightness 15%

- D) Brightness 20%
- E) Brightness 25%
- F) Brightness 30%
- G) Brightness 35%
- H) Brightness 40%
- I) Brightness 45%
- J) Brightness 50%

Menu 7 – *no.wave flashing sequence (smooth direction indicators)*

- A) Function deactivated
- B) Function activated

Menu 8 – *Light configuration*

- A) Lights on after engine start
- B) Lights on with ignition on
- C) Manual switch-on (light switch)
- D) Lights on after engine start – and off with kill pressed
- E) Lights on after engine start – and off after 60s of ignition off (garage light)

Menu 9 – *AUX1*

- A) Use as rear light output (active, when light is active)
- B) Active with ignition on
- C) Active after engine start
- D) ON / OFF with pushbutton connected to *AUX1* input
- E) ON / OFF with switch connected to *AUX1* input

Menu 10 – AUX2

- A) Active with ignition on
- B) Active after engine start
- C) ON / OFF with pushbutton connected to AUX2 input (no speedsensor possible)
- D) ON / OFF with switch connected to AUX2 input (no speedsensor possible)
- E) Active with ignition on / deactivate 120s after ignition off

Menu 11 – Side stand

- A) Input deactivated
- B) Input used as N/C contact (engine start enabled when input is open)
- B) Input used as N/O contact (engine start enabled when input switched to earth)

Menu 12 – Parking light

- A) Not active
- B) Dimming low beam - active
- C) Dimming low beam - 1h active
- D) Dimming low beam - 3h active
- E) Dimming low beam - 6h active
- F) Output AUX1 - active
- G) Output AUX1 - 1h active
- H) Output AUX1 - 3h active
- I) Output AUX1 - 6h active

9.2 Starting setup

Put the bike in an upright position to its main stand. To start the setup, press and hold the horn pushbutton while switching ignition on. A setup start is displayed by a brief blinker flashing. After this you can release the horn pushbutton.

(If you are not able to start the setup your *mo.unit*'s firmware is older than version 1032, which requires to switching ignition on and the pressing horn pushbutton three time rapidly. In this case you need the matching instruction manual.)

9.3 Navigation in setup

The LEDs on the input side represent the setup menus no. 1 to 12. All LED on the output side display the options A to J of the selected menu. The LED flashing sequence displays either the currently active menu item or selectable option. Press the horn pushbutton briefly to switch to the next menu / option. Press the horn pushbutton for an extended time (2s) to toggle between menu and option. The drawing on the following page contains an overview of all menus and selectable options.

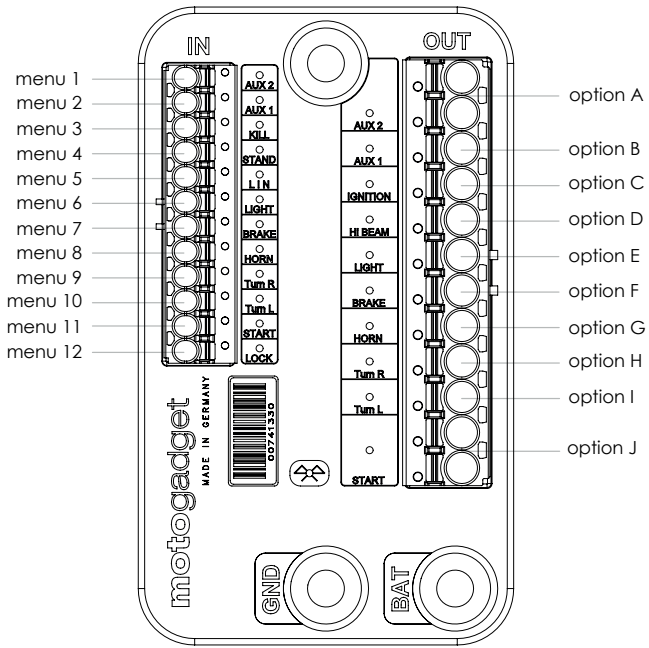

9.4 Exit from setup

Press and hold down the horn pushbutton until the device changes back to normal operation mode.

9.4.1 Calibration

When exiting from setup, the *mo.unit* calibrates itself so as to be able to detect any defective lamps while operating. For this purpose, the *TURNR*, *TURNL*, *LIGHT*, *HiBEAM*, *BRAKE* and *AUX1* outputs are successively switched on to measure the individual currents at each output.

In case of a defective lamp, a message is transmitted to the *mo.ride* app and, if possible, the change to a different lamp is executed (low beam / high beam, or rear light / brake light, respectively). In case of a defective direction indicator light, the flashing frequency is doubled – in accordance with legal regulations.

Therefore, every time the existing wiring is changed or a different illuminant is used, the setup needs to be started and exited for re-calibration.

The *mo.unit* also measures its position during the calibration process, thus the bike needs to remain standing in an upright position on the main stand.

9.5 Setup example

The following example is intended to demonstrate the operation in setup mode. The alarm is deactivated. The example shows how to set it to option D (pre-alarm 10s, medium sensitivity).

Setup Start
(ignition on + 3 x horn)



menu 1 - handlebar switches
chosen
(LED blinking)

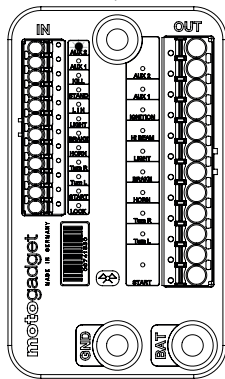

menu 5 - alarm chosen
(LED blinking)

press horn briefly 4 times
to change the menu

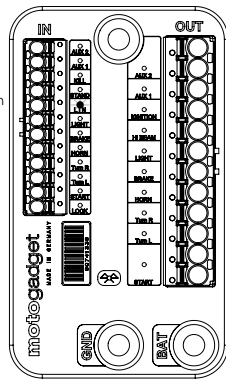

hold horn 2 seconds
for toggle to options



(Setup example continued on next page)

menu 5 - active
(LED continuous on)

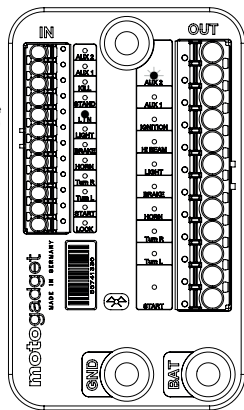

hold horn 2 seconds
for toggle to options

option A chosen
(LED blinking)

press horn briefly 3 times
to change option

hold horn 2 seconds
for toggle to menu

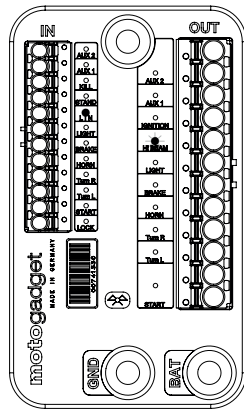

option D chosen
(LED blinking)

(Setup example continued on next page)

menu 5 - alarm chosen
(LED blinking)

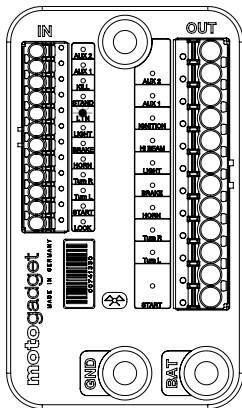

hold horn 2 seconds
for toggle to menu

hold horn pressed down until mo.unit
switches back to normal operation

calibration ensues
setup completed

10 Pairing the *mo.unit* with a smartphone (not *mo.unit basic*)

Install the *mo.ride* app (Android6.0 / iOS10.0 or higher required restricted compatibility of device manufacturer and model apply). Add a new bike into the garage and open it. Now tap on the blue button “hardware pairing” and follow the instructions.

Pairing step 1 of 3

Make sure *mo.unit* is connected completely to the vehicle and ready for operation.

Pairing step 2 of 3

Here you start the *mo.units* setup menu.

Please notice there are two possible ways to start the setup:

- a) holding horn pushbutton and then switching ignition on.
- b) switching ignition on and pressing the horn pushbutton three times rapidly.

If the horn is sounding you are NOT in the setup.

If there was no brief blinker flashing you are NOT in the setup. Also refer to chapter 9.2.

Pairing step 3 of 3

Hold the starter pushbutton für 10 seconds until the blinkers are flashing. Then confirm in the App as well. If the starter is cranking you are NOT in the setup.

10.1 Re-Pairing the *mo.unit* (not *mo.unit basic*)

If the *mo.unit* was paired with the phone and need to be paired again, make sure the *mo.unit* is deleted from the list of connected devices in the phones Bluetooth setup screen.

For Apple devices (iOS) the *mo.unit* must be “ignored” in the list of connected Bluetooth devices. If you have more then one *mo.unit* paired with the phone, all *mo.units* need to be “ignored” and then paired again.

10.2 Pairing multiple phones (not *mo.unit* basic)

An *mo.unit blue* can be paired with a maximum of 5 different Smartphones at the same time. Connecting to the 6th device will override the 1st device in memory.

11 Reset

To delete all internal data such as Bluetooth-devices, odometer, settings, and events, start the setup. Now hold the start and horn pushbuttons together for 10s. A successful reset will be indicated by a brief flashing of the blinkers. We recommend a reset particularly if the *mo.unit* was purchased in used condition, prior to installation.

12 Troubleshooting

12.1 After installation and on initial start-up

- Ensure that the battery provides a sufficient voltage of 12.4V minimum (ignition off).
- Check for the optimal ground connection between mounting bolt of the *mo.unit* and negative battery terminal (vehicle earth).
- Do not use a battery charger to check the device functionality.
- Due to permanently applied low voltages, it is not possible to measure the voltages at the inputs and outputs. These voltage values do not provide any information in terms of the correct functionality of the input/output. A functional test must always be carried out using a suitable load (e.g. a 20W light bulb).
- Check all cables for correct connection and contact, proper polarity, short-circuit and short-circuit to ground.

Error	Reason	Action
Alarm system not functioning	Feature is not activated	Set Setup Menu Item 5 to Option C-J
When activating the starter, mo.unit switches off and re-starts (chaser light is displayed)	Battery voltage collapses when attempting to start the engine	Check connecting cables, charge battery or replace battery (if necessary)
When attempting to start, mo.unit switches off the starter output (LED flashes)	Poor electrical connection between vehicle earth and connector pin of mo.unit	Route a separate cable from negative battery terminal to one of the connector pins
	Current flow through starter or original starter relay too high	Use a separate starter relay
	Poor electrical connection between battery and vehicle's electrical system	Establish suitable connection, use suitable ground cable
mo.unit switches off the electrical consumer (LED flashes)	Poor electrical connection between vehicle ground and connector pin	Route a separate cable from negative battery terminal to one of the connector pins
	Poor electrical connection at connecting terminal of mo.unit	Use end ferrules, check cable cross-section, re-connect cable
	Current flow of load too high	Connect suitable load (bulb, 2x 60W max.)
	Short-circuit on output	Eliminate short-circuit
Both direction indicators are lit/glowing permanently	Position lights are activated	Set Setup Menu Item 6 to Option A

12.2 Operational Modes

switch / button	Stage 1 press < 0,5s	Stage 2 press 0,5s - 2s	Stage 3 press > 2s	Condition (starting from Firmware 1028)
Light	high beam flashing	toggle low / high beam	light off	ignition on & light on
	light on			ignition on & light off
	parking light on			setup menu 12 / Option B-I and operating light pushbutton / switch while switching ignition off
Horn	honk			ignition on
			start setup	hold horn pushbutton while switching ignition on
	start speedsensor teach	-	-	ignition on & riding 50km/h & 3 times brief pushing
	alarm deactivated non-recurring			operating horn pushbutton while switching ignition off
Turn	lane change	turn with shut-off	turn without shut-off	ignition on & setup menu 3 / option B-E
	hazard flasher	-	-	ignition on & toggle switch 3x briefly form side to side
	hazard flasher			ignition on & hold both pushbuttons simultaneously
Start	crank engine			ignition on
	kill engine	-	-	ignition on & engine on & 2x stage 1 (doubleclick)
	electrical system turn on			ignition off and in Keyless-Go Range
	electrical system turn off	-	-	ignition on with Keyless Go & engine kill & 2x stage 1 (doubleclick)

12.3 Return and complaints

Before returning your *mo.unit* for technical inspection, contact our technical support.

Therefore, visit our website and follow the instructions in area “support”. Please provide the following informations completely: *mo.unit* serial no. (serial label on top of *mo.unit*), your smartphone model, app version (see *mo.ride* main menu “Info”), *mo.unit* firmware version (see *mo.unit* status screen in im *mo.ride* app). For returning an item follow the instruction in chapter “service” on our website.

CE marking

The unit described in this document is in accordance with the official European directives. A copy of the declaration of conformity can be provided on request. This equipment complies with the essential requirements of EU Directive 1999/5/EC. The vehicle body control module integrated in this product has been pre-certified separately and is marked with CE0168 R&TTE directive.

Hereby, *motogadget* declares that *motogadget* products and accessories are in compliance with the essential requirements and other relevant provisions of the EU Directive 1999/5/EC.

WEEE directive

The wheelie bin symbol on the product or its packaging indicates that this product shall not be treated as household waste. In line with EU Directive 2002/96/EC for waste electrical and electronic equipment (WEEE), this electrical product must not be disposed of as unsorted municipal waste. Please dispose of this product by returning it to the point of sale or to your local municipal collection point for recycling. By doing so you will help conserve the environment.

Regulations

PRODUCT INFORMATION:

Manufacturer: motogadget GmbH

Model: mo.unit blue

FCC ID: 2AIF8-4002040

IC: 21495-4002040



FCC COMPLIANCE STATEMENT:

This device complies with part 15 of the FCC Rules. Operation is subject to the following two conditions:

(1) This device may not cause harmful interference, and (2) this device must accept any interference received, including interference that may cause undesired operation.

INFORMATION TO USER:

This equipment has been tested and found to comply with the limits for a Class B digital device, pursuant to Part 15 of FCC Rules. These limits are designed to provide reasonable protection against harmful interference in a residential installation. This equipment generates, uses, and can radiate radio frequency energy.

If not installed and used in accordance with the instructions, it may cause harmful interference to radio communications. However, there is no guarantee that interference will not occur in a particular installation.

If this equipment does cause harmful interference to radio or television reception, which can be determined by turning the equipment off and on, the user is encouraged to try and correct the interference by one or more of the following measures:

- Reorient or relocate the receiving antenna
- Increase the distance between the equipment and the receiver
- Connect the equipment to outlet on a circuit different from that to which the receiver is connected
- Consult the dealer or an experienced radio/TV technician for help.

Canada – Industry Canada (IC)

This device complies with Industry Canada license-exempt RSS Standard(s). Operation is subject to the following two conditions:

(1) This device may not cause interference, and (2) this device must accept any interference, including interference that may cause undesired operation of the device.

Cet appareil est conforme avec Industrie Canada exempts de licence standard RSS (s). Son fonctionnement est soumis aux deux conditions suivantes:

(1) Cet appareil ne doit pas provoquer d'interférences et (2) cet appareil doit accepter toute interference, y compris celles pouvant causer un mauvais fonctionnement de l'appareil.

The motogadget team wishes you pleasant and safe riding, and lots of fun with your new mo.unit.